

SCHEDA TECNICA / SPECIFICATIONS

Art. RM590

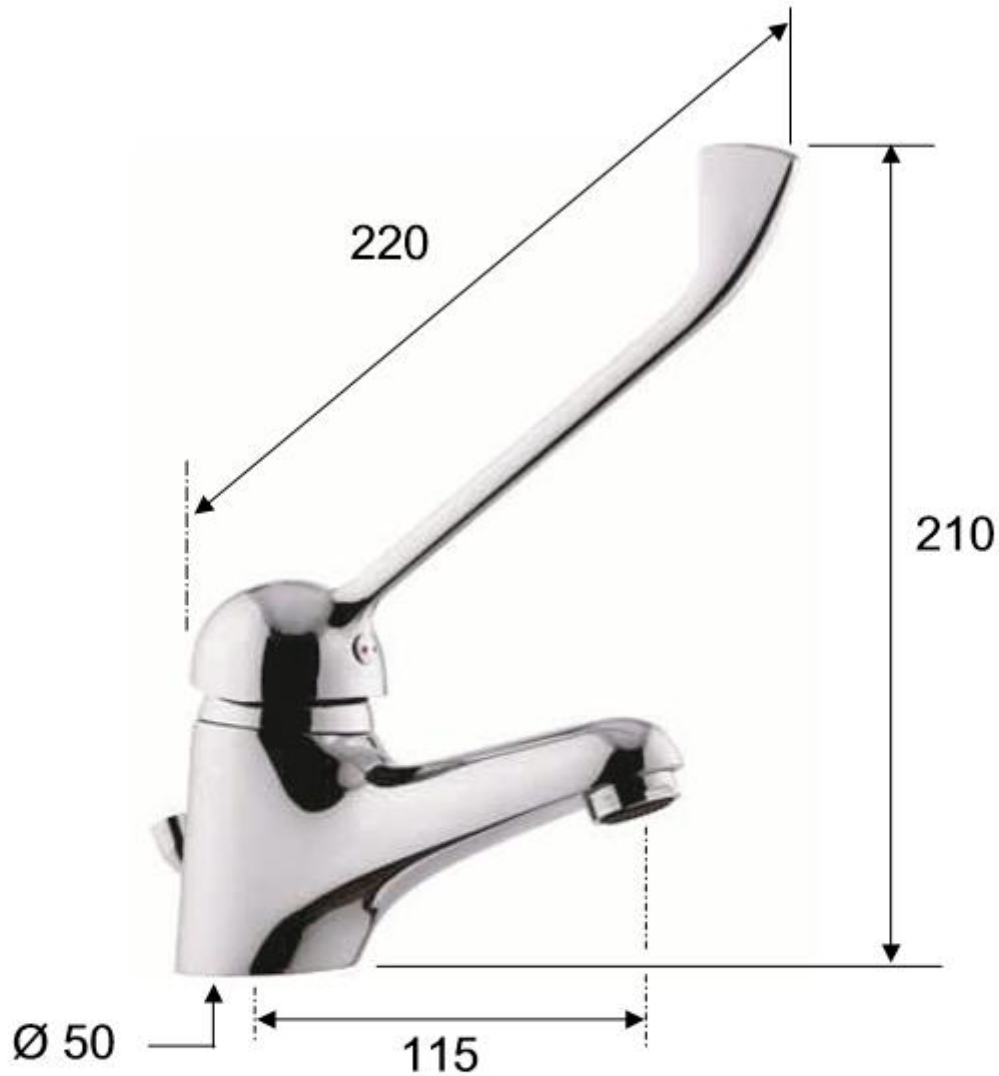

MATERIALI / MATERIALS

OTTONE CROMATO / CHROME PLATED BRASS

CROMATURA / CHROME PLATING

UNI EN 248