

**SCHEDA TECNICA / SPECIFICATIONS**

Art. RM720

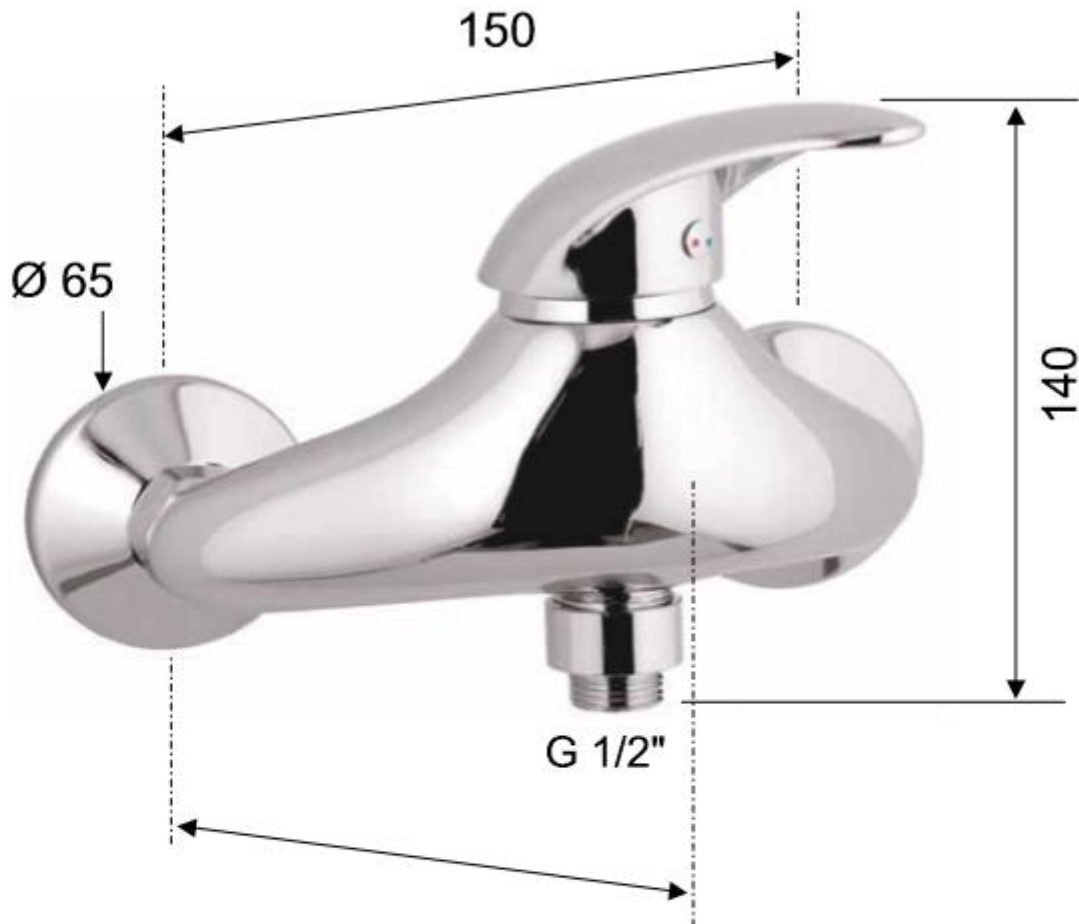

**MATERIALI / MATERIALS**

OTTONE CROMATO / CHROME PLATED BRASS

**CROMATURA / CHROME PLATING**

UNI EN 248