

I nostri profili - **MADE IN ITALY** - sono realizzati in PVC con finitura trasparente ed elevate caratteristiche di qualità



FORMATI

Tutti profili hanno una lunghezza di 200 cm e si possono facilmente tagliare a misura.

Il **profilo G3** per il montaggio in orizzontale ha anche l'alternativa da 100 cm.

Il **profilo G3 curvo** misura 80 cm e ha una curvatura media rispetto ai piatti doccia più diffusi.

Esistono diversi profili per vetri box doccia di differenti spessori; dopo aver misurato con un calibro lo spessore, possiamo scegliere il profilo più adatto.

SPESSORI

I profili possono avere una **misura unica**, oppure una **doppia misura** che permette di essere applicato su 2 spessori di vetro differenti.

Questa caratteristica è indicata in catalogo con 3 diversi bollini:

- i profili contraddistinti con il **bollino giallo** hanno la caratteristica di entrare perfettamente nella misura inferiore ma fermarsi leggermente prima nella misura superiore
- i profili contraddistinti con il **bollino verde** entrano perfettamente fino in fondo in entrambe le misure
- i profili contraddistinti con il **bollino azzurro** sono quelli solo con una misura unica.

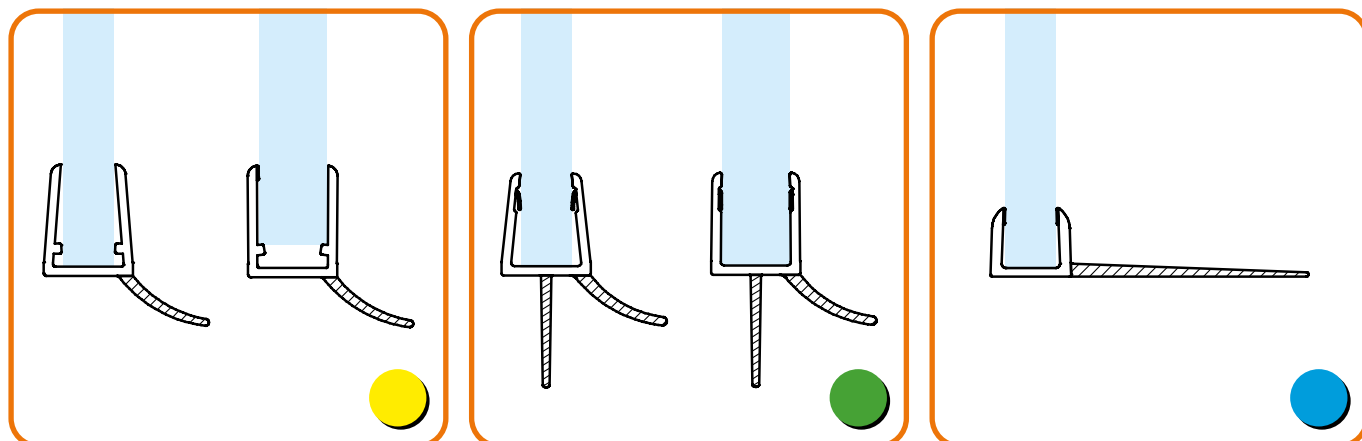

Profili per box doccia

Spessore Cristallo 4 mm

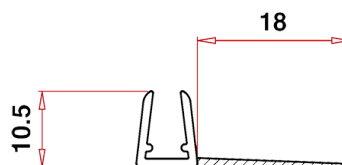

Codice: **PG013-418**
Articolo: **Profilo F4 Vetro 4 Baffo 18**
Spessore Cristallo: **4 mm**
Spessore Labbro morbido: **18 mm**
Lunghezza Totale: **200 cm Made in Italy**

Spessore Cristallo 4/5 mm

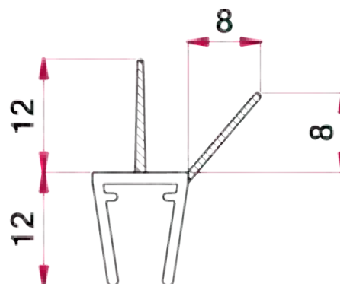

Codice: **P407**
Articolo: **Profilo G3 Mini Brico Vetro 4/5**
Spessore Cristallo: **4/5 mm**
Lunghezza Totale: **100 cm Made in Italy**

Spessore Cristallo 5 mm

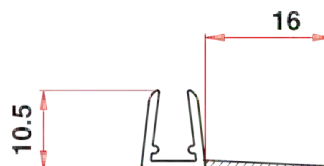

Codice: **PG013-516**
Articolo: **Profilo F5 Vetro 5 Baffo 16**
Spessore Cristallo: **5 mm**
Spessore Labbro morbido: **16 mm**
Lunghezza Totale: **200 cm Made in Italy**

Profili per box doccia

Spessore Cristallo 6 mm

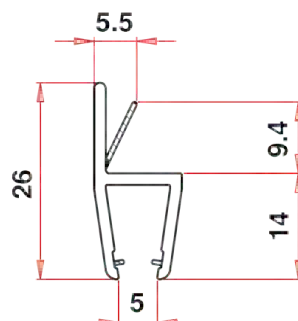

Codice: **PG160**
Articolo: **Profilo PG160**
Spessore Cristallo: **6 mm**
Spessore Labbro rigido: **12 mm**
Lunghezza Totale: **200 cm Made in Italy**

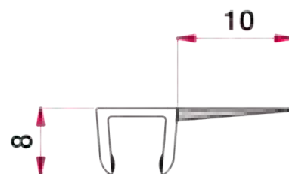
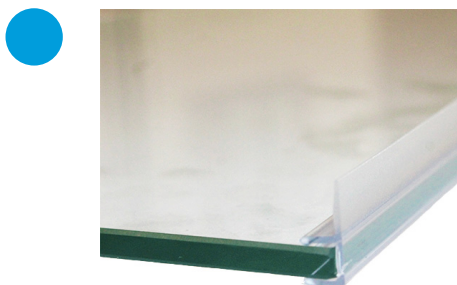

Codice: **PG016.10**
Articolo: **Profilo F3 Vetro 6 Baffo 10**
Spessore Cristallo: **6 mm**
Spessore Labbro morbido: **10 mm**
Lunghezza Totale: **200 cm Made in Italy**

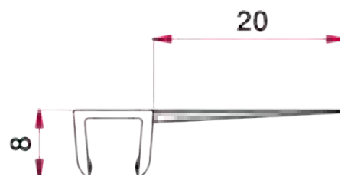
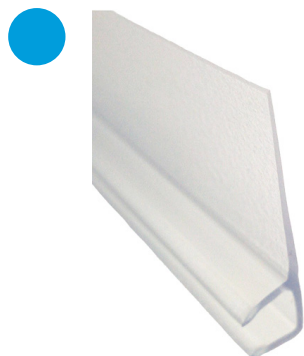

Codice: **PG016.20**
Articolo: **Profilo F3 Vetro 6 Baffo 20**
Spessore Cristallo: **6 mm**
Spessore Labbro morbido: **20 mm**
Lunghezza Totale: **200 cm Made in Italy**

Profili per box doccia

Spessore Cristallo 6 mm



Codice: **PG056**
Articolo: **Profilo P6 Vetro 6**
Spessore Cristallo: **6 mm**
Spessore Palloncino morbido: **7 mm**
Lunghezza Totale: **200 cm Made in Italy**

Spessore Cristallo 6/8 mm

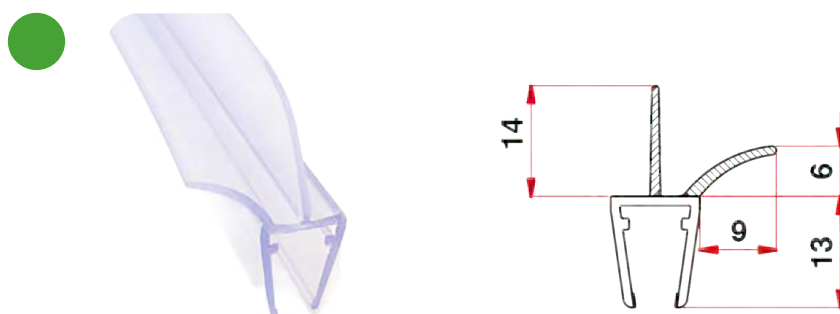

Codice: **P401/14**
Codice: **P401/14M**
Articolo: **Profilo G3 Vetro 6/8 Baffo 14**
Spessore Cristallo: **6/8 mm**
Spessore Labbro morbido: **14 mm**
Lunghezza Totale: **200 cm / 100 cm Made in Italy**

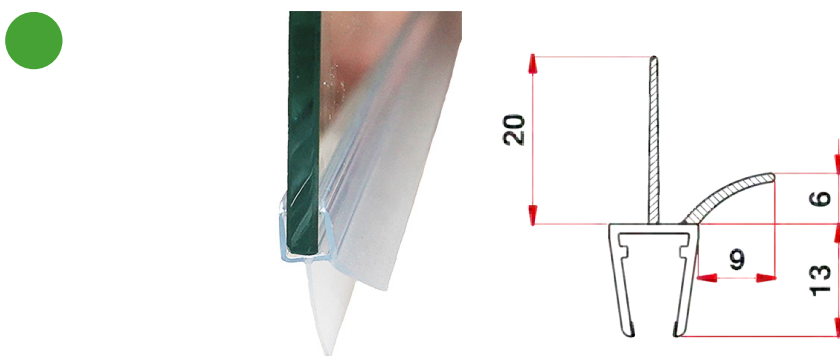

Codice: **P401/20**
Codice: **P401/20M**
Articolo: **Profilo G3 Vetro 6/8 Baffo 20**
Spessore Cristallo: **6/8 mm**
Spessore Labbro morbido: **20 mm**
Lunghezza Totale: **200 cm / 100 cm Made in Italy**

Profili per box doccia

Spessore Cristallo 6/8 mm

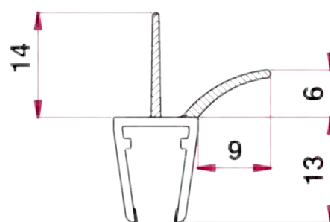

Codice: **PG401/14C**
Articolo: **Profilo G3 curvo Vetro 6/8 Baffo 14**
Spessore Cristallo: **6/8 mm**
Spessore Labbro morbido: **14 mm**
Lunghezza Totale: **80 cm Made in Italy**

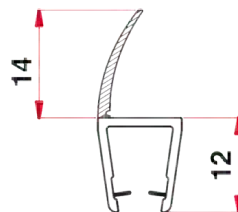

Codice: **P405/14**
Articolo: **Profilo H3 Vetro 6/8 Baffo 14**
Spessore Cristallo: **6/8 mm**
Spessore Labbro morbido: **14 mm**
Lunghezza Totale: **200 cm Made in Italy**

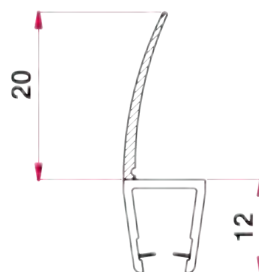

Codice: **P405/20**
Articolo: **Profilo H3 Vetro 6/8 Baffo 20**
Spessore Cristallo: **6/8 mm**
Spessore Labbro morbido: **20 mm**
Lunghezza Totale: **200 cm Made in Italy**

Profili per box doccia

Spessore Cristallo 6/8 mm



Codice: **P409/6**
Articolo: **Profilo P6 6/8 Vetro 6/8**
Spessore Cristallo: **6/8 mm**
Spessore Palloncino morbido: **8 mm**
Lunghezza Totale: **200 cm Made in Italy**

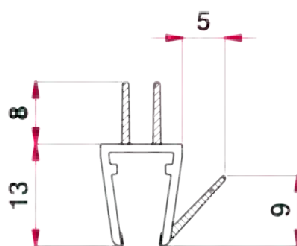

Codice: **PSB3**
Articolo: **Profilo SB3 Vetro 6/8 Baffo 8**
Spessore Cristallo: **6/8 mm**
Spessore Labbro morbido: **8 mm**
Lunghezza Totale: **200 cm Made in Italy**

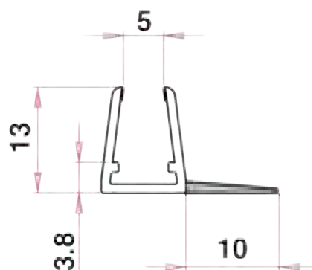

Codice: **P403/10**
Articolo: **Profilo F3 Vetro 6/8 Baffo 10**
Spessore Cristallo: **6/8 mm**
Spessore Labbro morbido: **10 mm**
Lunghezza Totale: **200 cm Made in Italy**

Profili per box doccia

Spessore Cristallo 6/8 mm

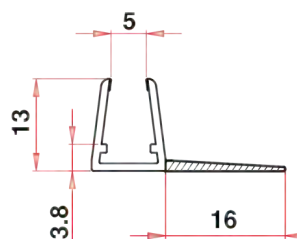

Codice: **P403/16**
Articolo: **Profilo F3 Vetro 6/8 Baffo 16**
Spessore Cristallo: **6/8 mm**
Spessore Labbro morbido: **16 mm**
Lunghezza Totale: **200 cm Made in Italy**

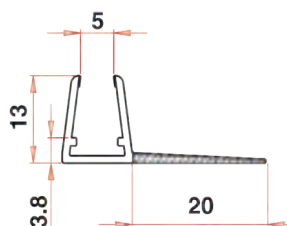

Codice: **P403/20**
Articolo: **Profilo F3 Vetro 6/8 Baffo 20**
Spessore Cristallo: **6/8 mm**
Spessore Labbro morbido: **20 mm**
Lunghezza Totale: **200 cm Made in Italy**

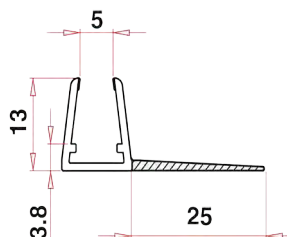

Codice: **P403/25**
Articolo: **Profilo F3 Vetro 6/8 Baffo 25**
Spessore Cristallo: **6/8 mm**
Spessore Labbro morbido: **25 mm**
Lunghezza Totale: **200 cm Made in Italy**

Profili per box doccia

Spessore Cristallo 6/8 mm

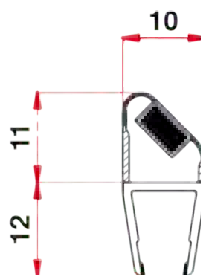

Codice: **P422A/422B**
Nome: **Coppia Chiusura a Calamita 45°**
Spessore Cristallo: **6/8 mm**
Lunghezza Totale: **200 cm Made in Italy**

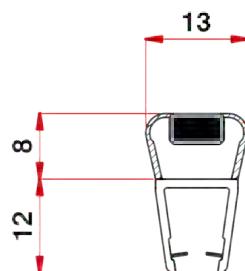
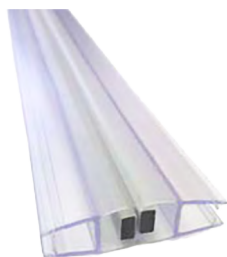

Codice: **P421**
Articolo: **Coppia Chiusura a Calamita Dritto**
Spessore Cristallo: **6/8 mm**
Lunghezza Totale: **200 cm Made in Italy**

Spessore Cristallo 8 mm

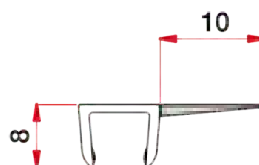

Codice: **PG018.10**
Articolo: **Profilo F3 Vetro 8 Baffo 10**
Spessore Cristallo: **8 mm**
Spessore Labbro morbido: **10 mm**
Lunghezza Totale: **200 cm Made in Italy**

Profili per box doccia

Spessore Cristallo 8 mm



Codice: **PG058**
Articolo: **Profilo P6 Vetro 8**
Spessore Cristallo: **8 mm**
Spessore Palloncino morbido: **7 mm**
Lunghezza Totale: **200 cm**
Made in Italy

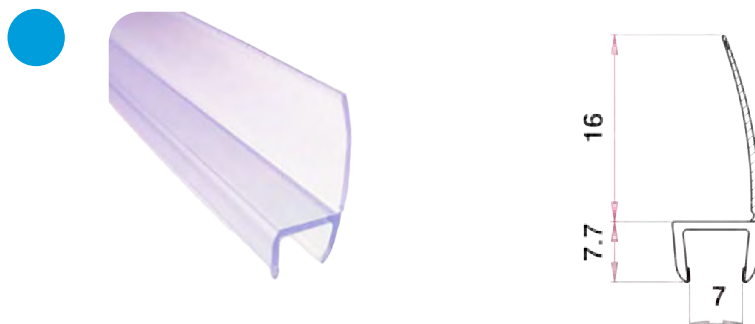

Codice: **PG048**
Articolo: **Profilo H3 Vetro 8 Baffo 16**
Spessore Cristallo: **8 mm**
Spessore Labbro morbido: **16 mm**
Lunghezza Totale: **200 cm** Made in Italy

Spessore Cristallo 8/10 mm

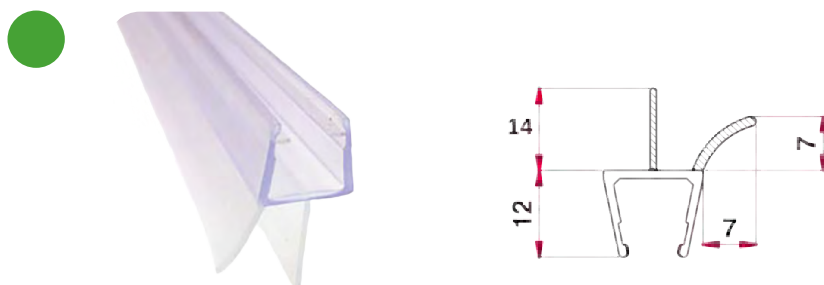

Codice: **PG023**
Codice: **PG023M**
Articolo: **Profilo G3 Vetro 8/10 Baffo 14**
Spessore Cristallo: **8/10 mm**
Spessore Labbro morbido: **14 mm**
Lunghezza Totale: **200 cm / 100 cm**
Made in Italy

Profili per box doccia

Spessore Cristallo 8/10 mm

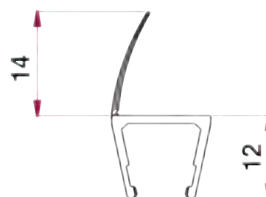

Codice: **PG043**
Articolo: **Profilo H3 Vetro 8/10 Baffo 14**
Spessore Cristallo: **8/10 mm Spessore**
Labbro morbido: **14 mm**
Lunghezza Totale: **200 cm Made in Italy**

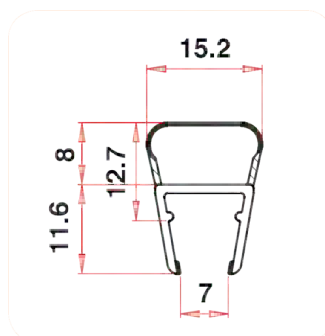

Codice: **P509**
Articolo: **Profilo P6 Vetro 8/10**
Spessore Cristallo: **8/10 mm**
Spessore Palloncino morbido: **8 mm**
Lunghezza Totale: **200 cm Made in Italy**

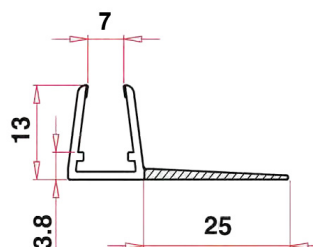

Codice: **PG025**
Articolo: **Profilo F3 Vetro 8/10 Baffo 25**
Spessore Cristallo: **8/10 mm**
Spessore Labbro morbido: **16 mm**
Lunghezza Totale: **200 cm Made in Italy**

Profili per box doccia

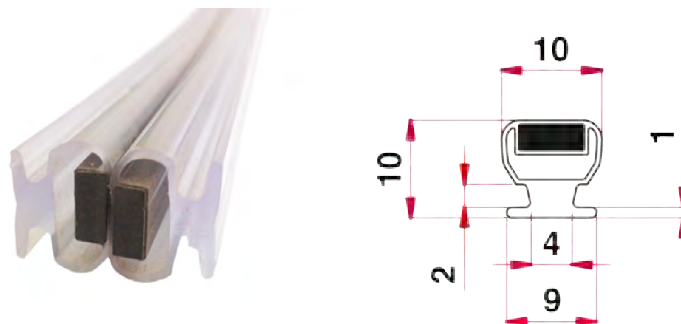

Codice: **M093**
Articolo: **Guarnizione a calamita trasparente**
Lunghezza Totale: **200 cm Made in Italy**

Spessore Cristallo 6 mm



Codice: **RIC1096**
Articolo: **Curvabile sul vetro**
Lunghezza totale = **100cm**
Spessore Vetro = **6 mm**

Top Project Hotel Srl
Via Carmine 33 Oleggio(NO)

info@tph.it
0321927123
3342272845